



29 rue du 14 juillet
67980 - Hangenbieten
FRANCE
Tel. : +33 3 88 48 53 00
www.soframe.com

DEFENSE



© SOFRAME - 052024- D190178 - All rights reserved. This document is the exclusive property of our company. All descriptions, specifications and characteristics are given for information only and do not represent a commitment of any kind. Non contractual photos.

APCL

Armoured Personal Carrier Light Vehicle



DEFENSE

EN



Technical characteristics

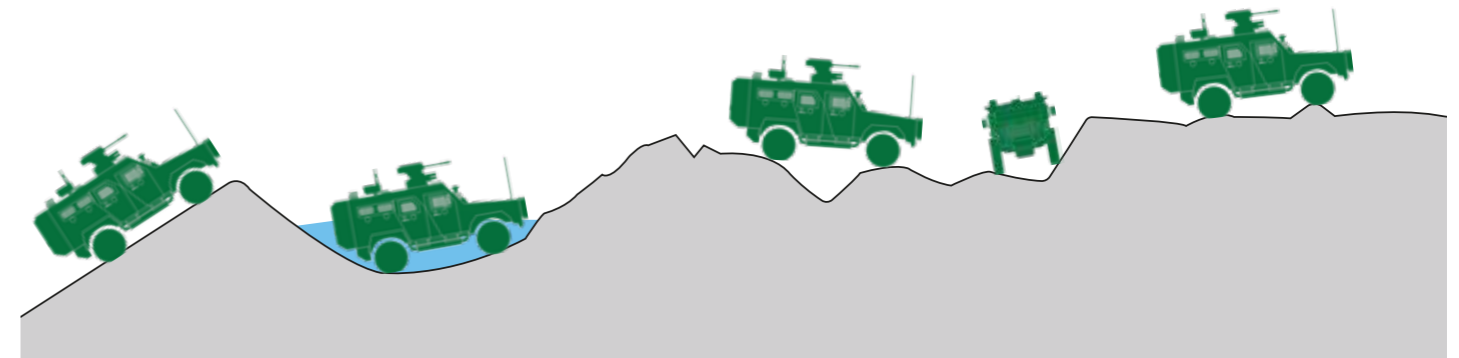
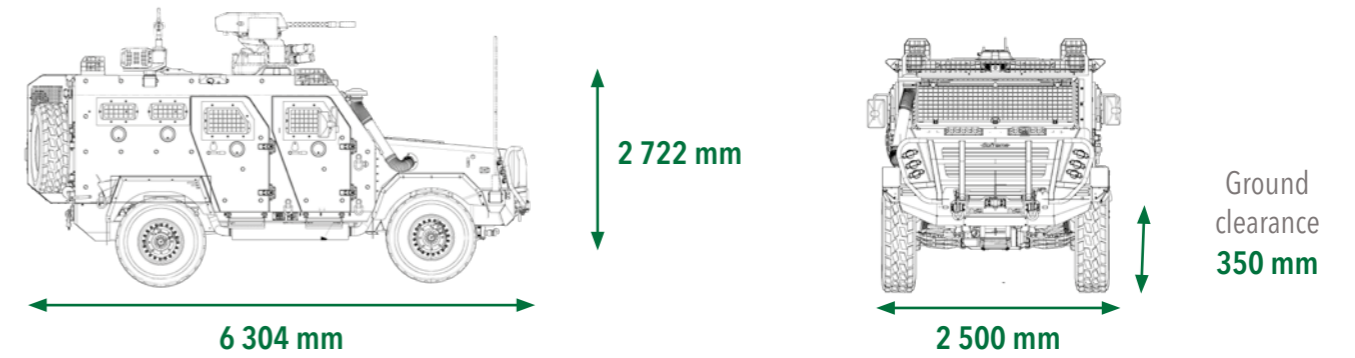









Slope **60 %** Fording **750 mm** Trench **900 mm** Side Sloope **30 %** Step **400 mm**

The **APCL** is a **protected rapid intervention** vehicle designed to operate in **extremely entangled areas and very varied terrains**. Its long range and all-terrain capability make it an extremely versatile vehicle.

It is a 4x4 military vehicle with a STANAG-certified armoured structure ensuring security and comfort for up to 8 people. The armour is **adaptable** to the required level of protection and can be increased.

Its independent suspension provides greater **comfort, better traction, improved safety and stability** both on- and off-road at low or high speed.

-  Protection: up to level 3
-  Engine: 210 kW (285 hp)
-  Gearbox: Automatic
-  GVWR: 12 t
-  Maximum speed: 110 km/h
-  Range: 600 km
-  Turning radius: 6.5 m
-  Crew: 8 people

An RCWS can be mounted on the vehicle and it can be equipped with a wide variety of mission equipment.